

Dimensions
 Face Width 48" 1219mm
 Back Width 39" 991mm
 Depth 24" 610mm
 Height 24" 610mm
 Face Area 8 sq ft 0.74 sq m
 Setback 2.4deg 1.0"/Unit
 Weight 1370lbs 621Kg*

STANDARD UNIT

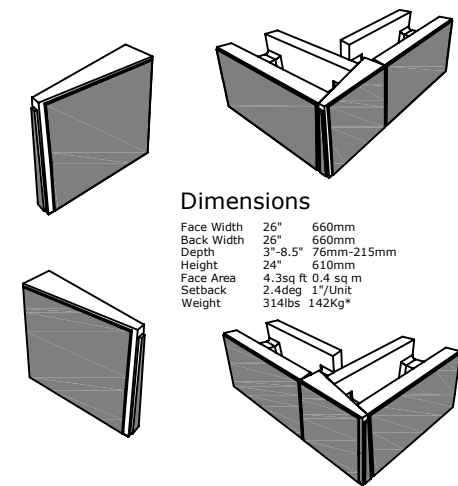

Dimensions
 Face Width 26" 660mm
 Back Width 26" 660mm
 Depth 3"-8.5" 76mm-215mm
 Height 24" 610mm
 Face Area 4.3sq ft 0.4 sq m
 Setback 2.4deg 1"/Unit
 Weight 314lbs 142Kg*

CORNER/END UNIT

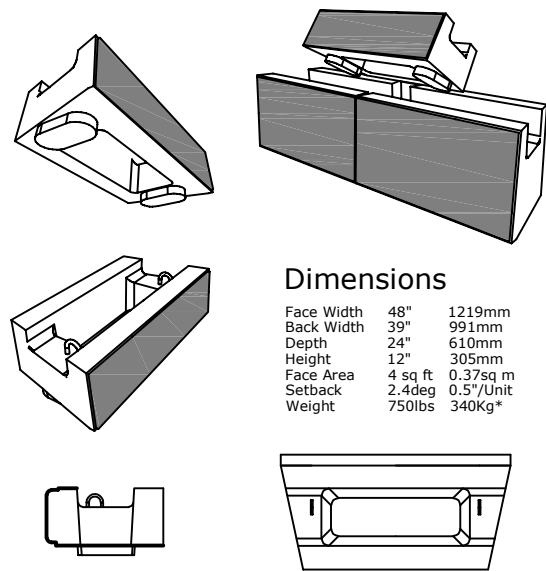

Dimensions
 Face Width 48" 1219mm
 Back Width 39" 991mm
 Depth 24" 610mm
 Height 12" 305mm
 Face Area 4 sq ft 0.37sq m
 Setback 2.4deg 0.5"/Unit
 Weight 750lbs 340Kg*

HALF HIGH UNIT

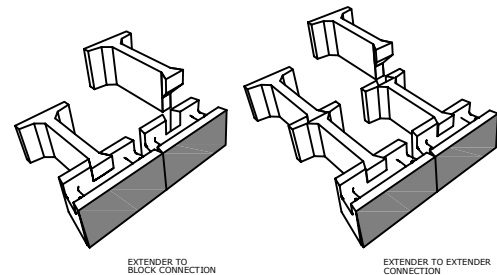

EXTENDER INSTALLATION

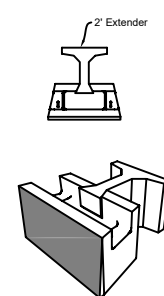

48" (1219MM)

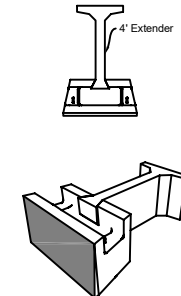

72" (1829MM)

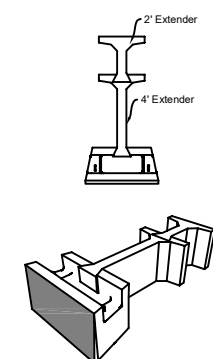

96" (2438MM)

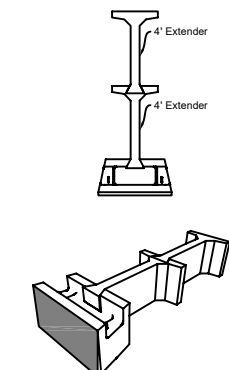

120" (3048MM)

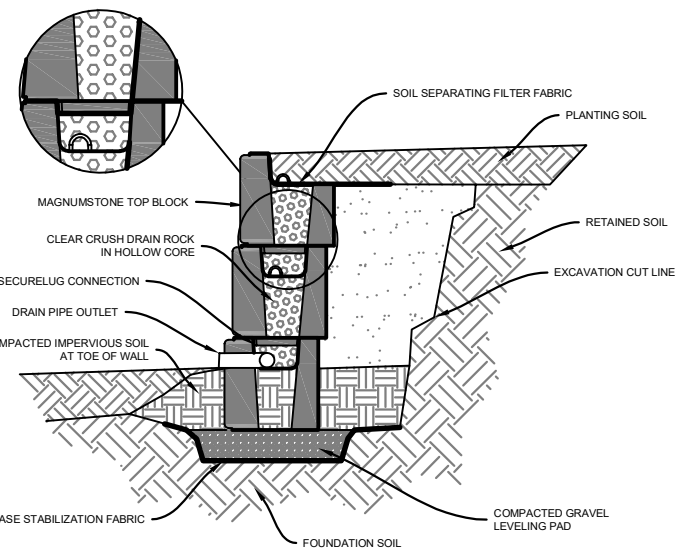

GRAVITY WALL

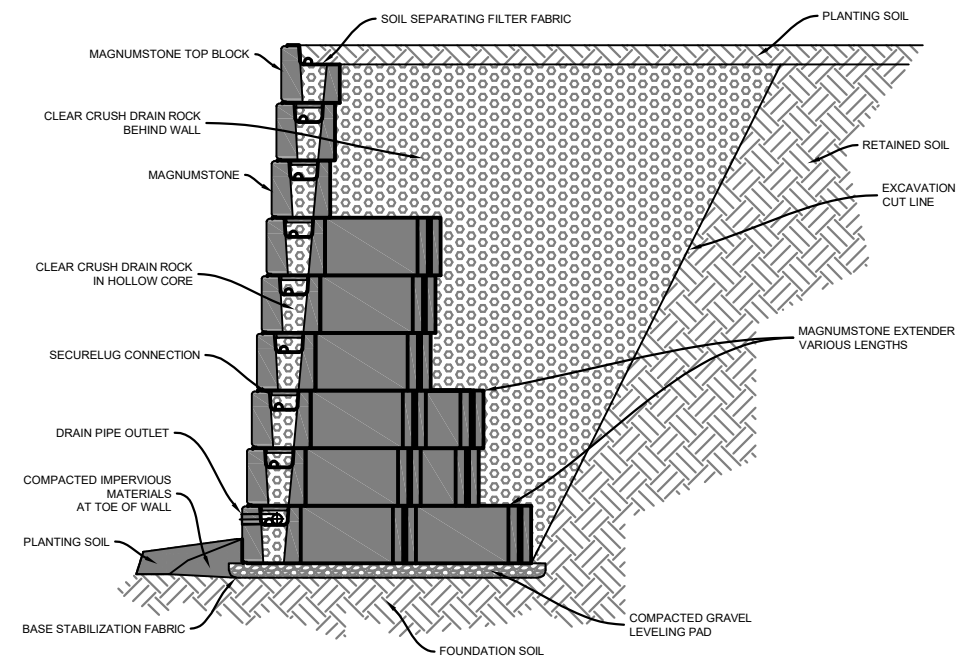

GRAVITY WALL WITH EXTENDERS

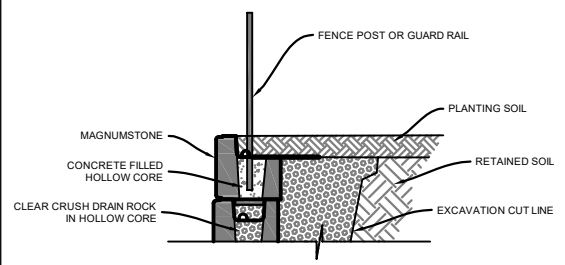

FENCE THROUGH HOLLOW CORE

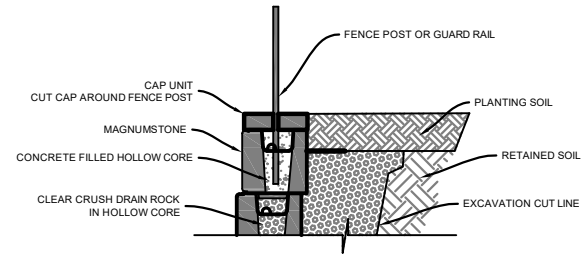

FENCE THROUGH HOLLOW CORE W /CAP

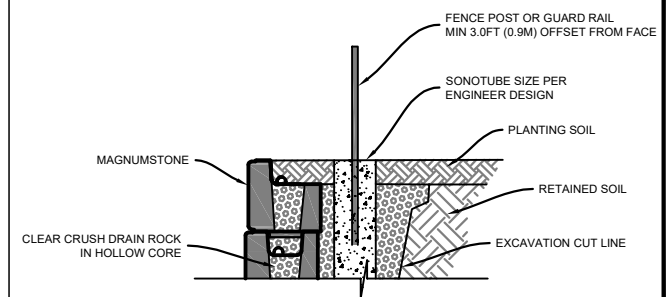

GUARD RAIL

General Notes

No.	Revision/Issue	Date



Project Name and Address

Project _____ Sheet _____
 Date _____
 Scale _____

FNAME

REVDATE

USER

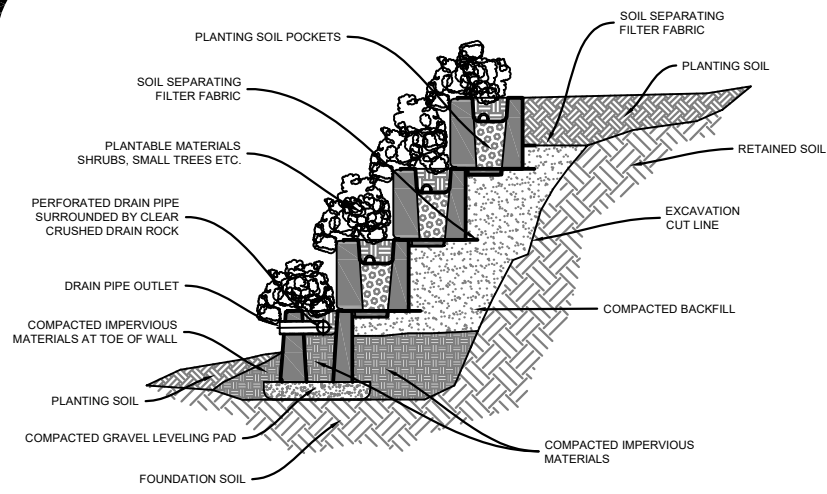

2.0 FT PLANTABLE WALL

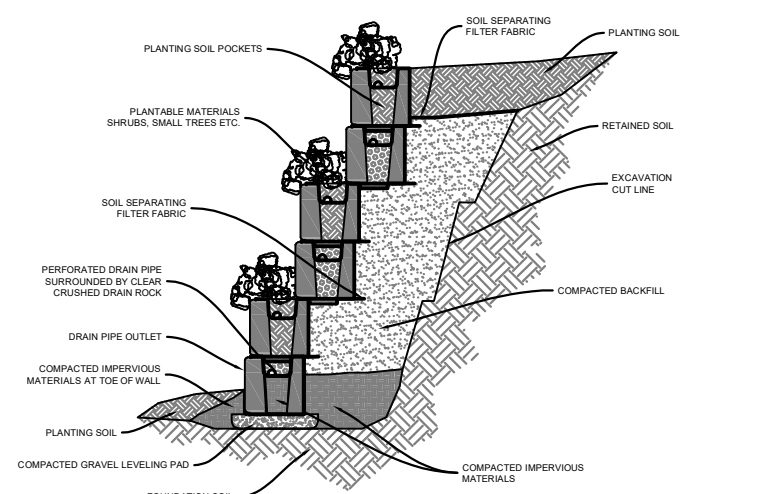

4.0 FT PLANTABLE WALL

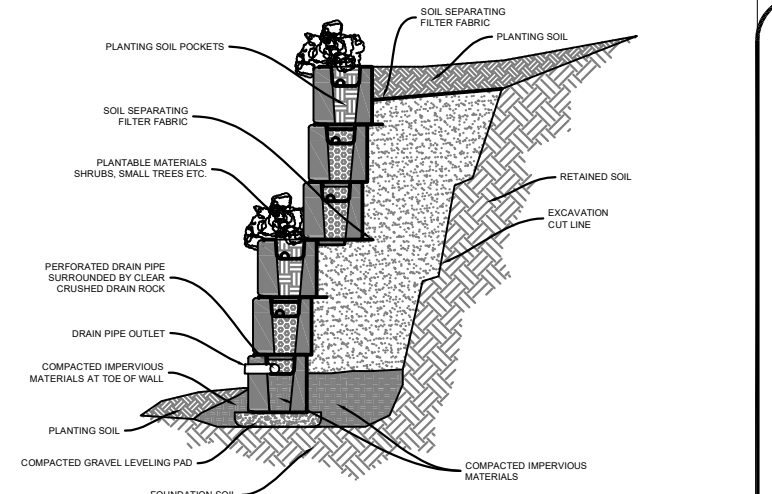

6.0 FT PLANTABLE WALL

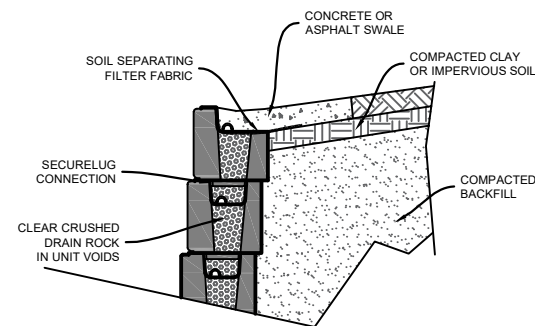

CONCRETE / ASPHALT SWALE

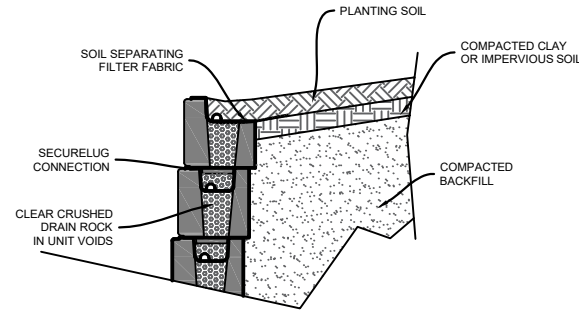

CLAY / IMPERVIOUS SWALE

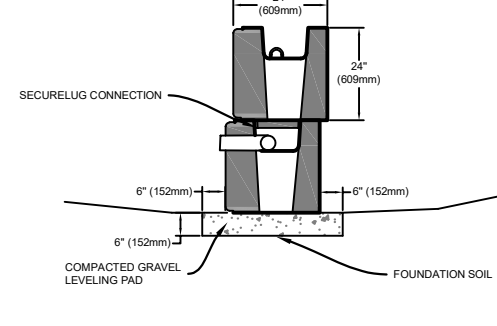

LEVELING PAD

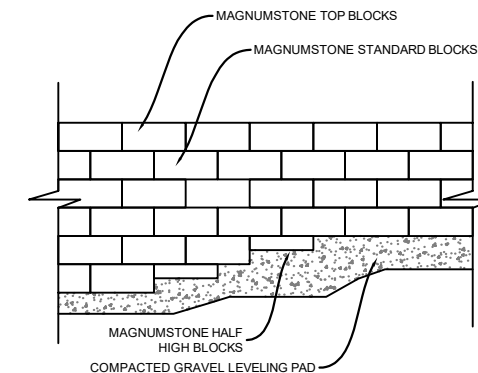

BASE STEP UP

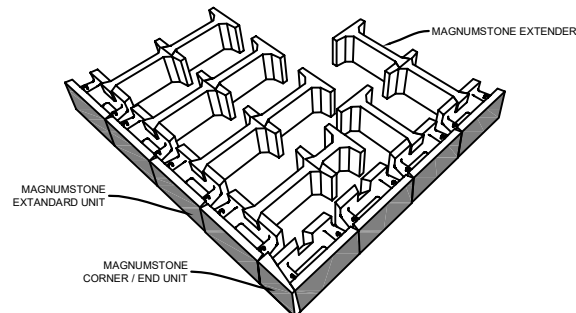
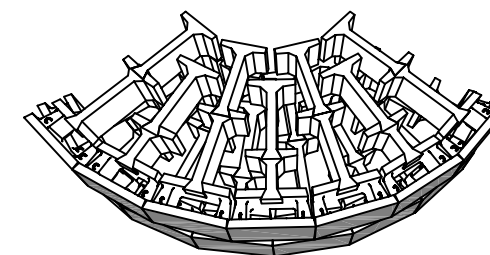
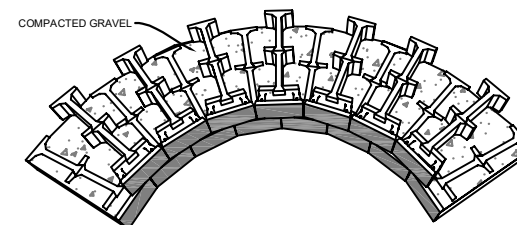
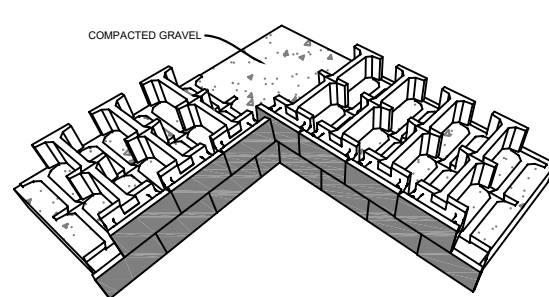
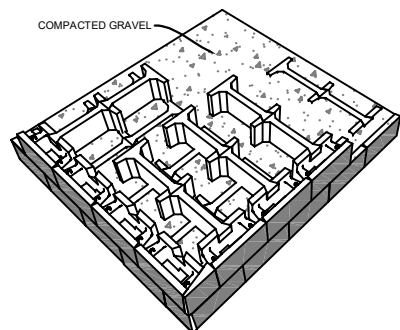

OUTSIDE CORNER

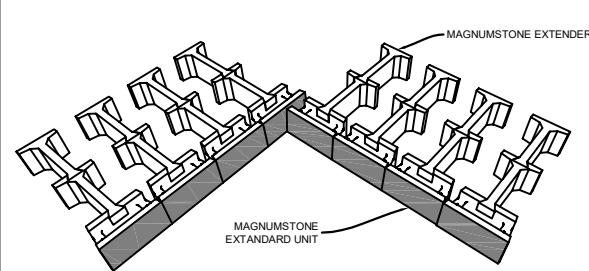

INSIDE CORNER

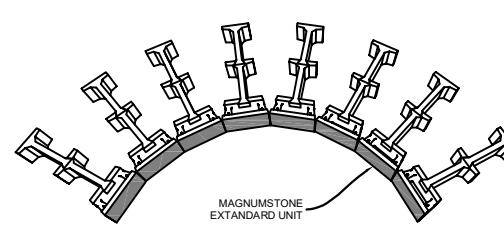

INSIDE CURVE

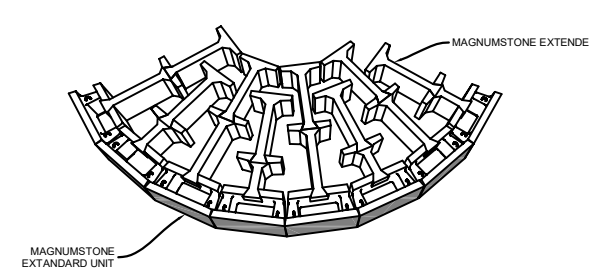

OUTSIDE CURVE

General Notes

No.	Revision/Issue	Date

MagnumStone™
by CORNERSTONE®

Project Name and Address

Project	Sheet
Date	
Scale	

FNAME

REVDATE

USER